

ECART



JEAN-MICHEL FRANK
(1895-1941)

UPHOLSTERED CHAIR
(c. 1925)

Varnished solid oak & fabric.

CM	IN
H. 90	H. 35.5
L. 43	W. 17
P. 56	P. 22

JEAN-MICHEL FRANK (1895-1941)

In the gap between the extravagant luxury of Art Deco and the political commitment of the modernist movement, Jean-Michel Frank invented a third path: an elegant spatial expression through minimalism. His trajectory is akin to that of Gabrielle Chanel, who, like him, embraced simplicity in design.

He engaged with a community of avant-garde luxury, including artists, intellectuals, and aristocrats with liberated lifestyles. Jean-Michel Frank had a deep appreciation for people; his first clients were his friends or would become friends. As early as 1919, he designed the apartment of Colette Jéramec and Pierre Drieu la Rochelle, followed by his own apartment at 7 rue de Verneuil, which became his showcase. His list of clients was long and prestigious: Louis Aragon, André Breton, Paul Éluard, René Crevel, François Mauriac, Nancy Cunard. He worked on the Noailles' residence on Place des États-Unis, for a highly fashionable Parisian couple. His reputation was established, and he became a professional decorator, partnering with his cabinetmaker Adolphe Chanaux in October 1930.

Jean-Michel Frank was inspired by the history of styles, but his work incorporated poetic contrasts. Natural materials were key to the surfaces of his furniture, with rye straw's shifting effects, cloudy parchment, shagreen, gypsum, plaster, natural oak—sanded and scraped—sycamore veneer, sackcloth, leather, and rattan. The furniture formed a necessary counterpoint in the space conceived by Frank, its archetypal form softened by subtle tonal variations. The staff lamps designed by the Giacometti brothers further confirmed the softness of the decor.

With the 1929 crisis, a shift in the era was inevitable, but commissions continued: François Mauriac, Marcel Rochas, Jean-Pierre Guerlain, Lucien Lelong, and Nelson Rockefeller in New York. In 1935, he opened a boutique on rue du Faubourg Saint-Honoré, bearing his name, where he enjoyed welcoming clients and artists: Alberto and Diego Giacometti, Christian Bérard, Salvador Dalí, Paul Rodocanachi, and Emilio Terry.

In 1939, with the declaration of war, the workshops on rue de Montauban closed. Threatened as a Jew and homosexual, he left France. From Buenos Aires, he traveled to New York in 1941, where he ended his life by jumping from a building.



ECART



JEAN-MICHEL FRANK
(1895-1941)

UPHOLSTERED CHAIR
(c. 1925)

ECART



JEAN-MICHEL FRANK
(1895-1941)

UPHOLSTERED CHAIR
(c. 1925)

ECART



JEAN-MICHEL FRANK
(1895-1941)

UPHOLSTERED CHAIR
(c. 1925)

ECART

FABRICS

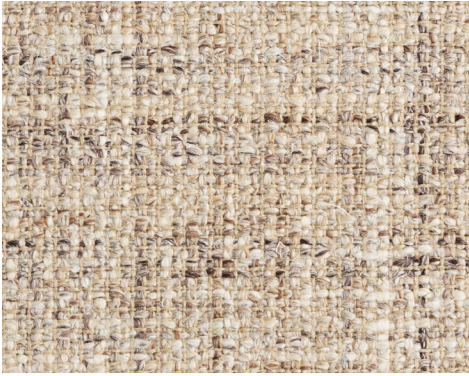

Edmond Chestnut



Christian Sand

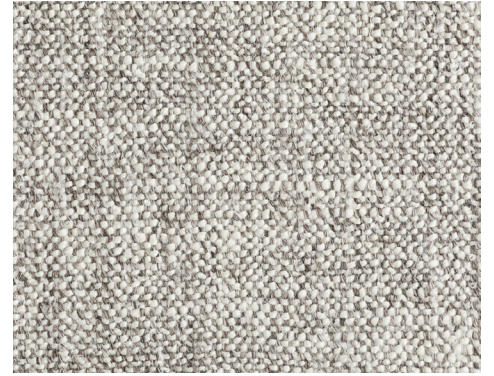

Waldemar Grey



Nancy Beige



Eugenia White

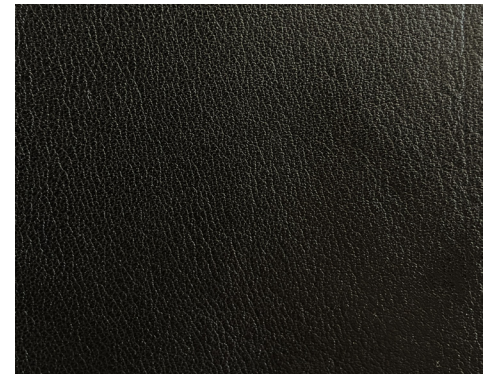

Black leather

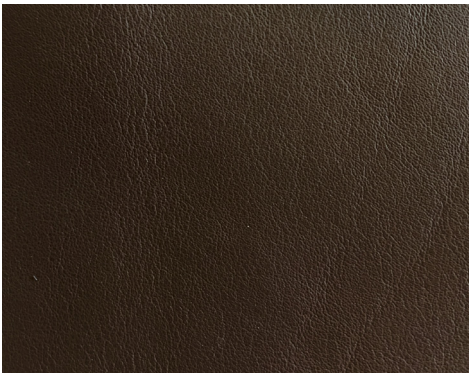

Dark chocolate leather



Cognac leather

WOOD

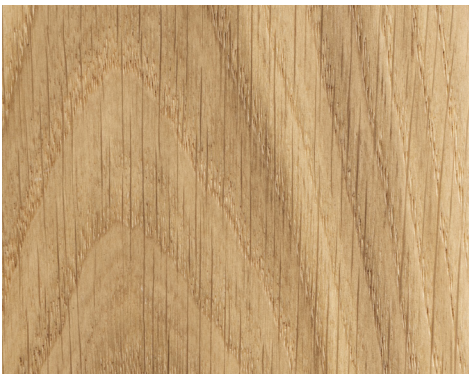

Smooth natural oak with matte varnish



Smooth brown oak with matte varnish

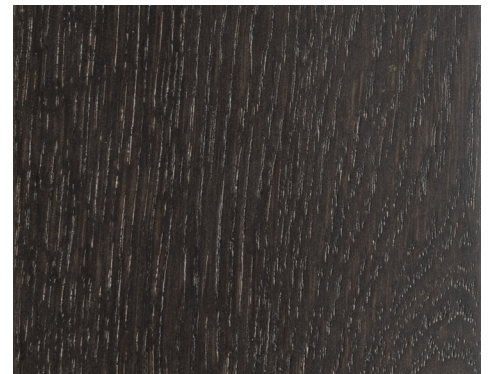

Smooth black oak with matte varnish

JEAN-MICHEL FRANK
(1895-1941)

UPHOLSTERED CHAIR
(c. 1925)

ECART

WOOD



Sandblasted natural oak with matte varnish



Sandblasted brown oak with matte varnish



Sandblasted black oak with matte varnish



Deep sandblasted natural oak with matte varnish



Deep sandblasted brown oak with matte varnish

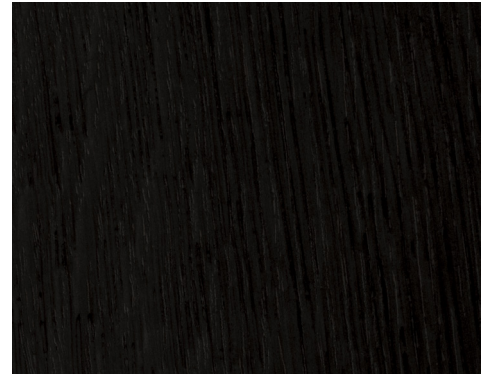

Deep sandblasted black oak with matte varnish

ECART

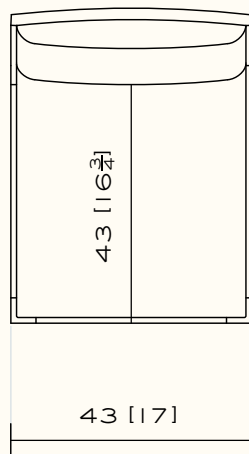
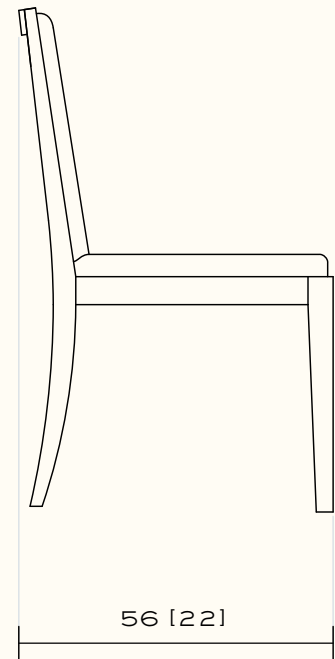
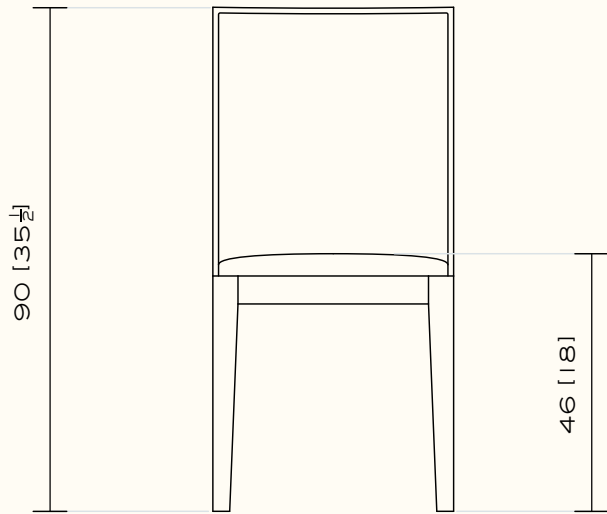

JEAN-MICHEL FRANK
(1895-1941)

UPHOLSTERED CHAIR
(c. 1925)

Upholstery: Fabric (COM: 1.2 m) or leather.
Frame: Natural, brown or black oak.
Finish: Smooth, sandblasted or deep sandblasted
with matte varnish.

ECART